

# TLP421

- Office Equipment
- Household Appliances
- Solid State Relays
- Switching Power Supplies
- Various Controllers
- Signal Transmission Between Different Voltage Circuits

The TOSHIBA TLP421 consists of a silicone photo-transistor optically coupled to a gallium arsenide infrared emitting diode in a four lead plastic DIP (DIP4) with having high isolation voltage (AC: 5kVRMS (min)).

- Collector-emitter voltage: 80V (min.)
- Current transfer ratio: 50% (min.)  
Rank GB: 100% (min.)
- Isolation voltage: 5000V<sub>rms</sub> (min.)
- UL recognized: UL1577
- BSI approved: BS EN60065: 1994  
Approved no.8411  
BS EN60950: 1992  
Approved no.8412
- SEMKO approved: EN60065, EN60950, EN60335  
Approved no.9910249/01

Unit in mm

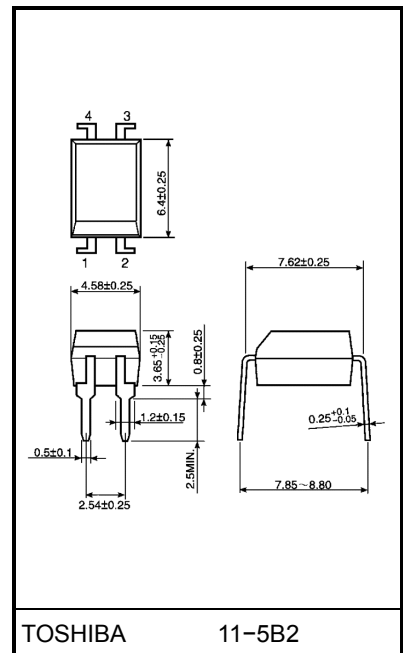

Weight: 0.26 g

## Pin Configurations (top view)

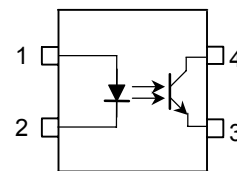

- 1 : Anode
- 2 : Cathode
- 3 : Emitter
- 4 : Collector

- Option(D4)type  
TÜV approved: DIN VDE0884  
Approved no.R9950202  
Maximum operating insulation voltage: 890V<sub>PK</sub>  
Maximu permissible overvoltage: 8000V<sub>PK</sub>

**(Note): When a VDE0884 approved type is needed, please designate the “Option(D4)”**

Making the VDE applocation: DIN VDE0884

- Construction mechanical rating

	7.62mm Pich Typical Type	10.16mm Pich TLPxxxF Type
Creepage distance	7.0mm(min)	8.0mm(min)
Clearance	7.0mm(min)	8.0mm(min)
Insulation thickness	0.4mm(min)	0.4mm(min)

## Current Transfer Ratio

Type	Classi- fication (*1)	Current Transfer Ratio (%) ( $I_C / I_E$ )		Marking Of Classification
		$I_F = 5mA, V_{CE} = 5V, T_a = 25^\circ C$		
		Min	Max	
TLP421	(None)	50	600	Blank, Y, Y+, G, G+, B, B+, GB
	Rank Y	50	150	Y, Y+
	Rank GR	100	300	G, G+
	Rank BL	200	600	B, B+
	Rank GB	100	600	G, G+, B, B+, GB

(\*1): Ex. rank GB: TLP421 (GB)

(Note): Application type name for certification test, please use standard product type name, i. e.  
TLP421 (GB): TLP421

**Maximum Ratings (Ta = 25°C)**

Characteristic		Stmbol	Rating	Unit
LED	Forward current	$I_F$	60	mA
	Forward current derating(Ta ≥ 39°C)	$\Delta I_F / ^\circ C$	-0.7	mA / °C
	Pulse forward current (Note 2)	$I_{FP}$	1	A
	Power dissipation	$P_D$	100	mW
	Power dissipation derating	$\Delta P_D / ^\circ C$	-1.0	mW / °C
	Reverse voltage	$V_R$	5	V
	Junction temperature	$T_j$	125	°C
Detector	Collector-emitter voltage	$V_{CEO}$	80	V
	Emitter-collector voltage	$V_{ECO}$	7	V
	Collector current	$I_C$	50	mA
	Power dissipation(single circuit)	$P_C$	150	mW
	Power dissipation derating (Ta ≥ 25°C)(single circuit)	$\Delta P_C / ^\circ C$	-1.5	mW / °C
	Junction temperature	$T_j$	125	°C
Operating temperature range		$T_{opr}$	-55~100	°C
Storage temperature range		$T_{stg}$	-55~125	°C
Lead soldering temperature (10s)		$T_{sol}$	260	°C
Total package power dissipation		$P_T$	250	mW
Total package power dissipation derating (Ta ≥ 25°C)		$\Delta P_T / ^\circ C$	-2.5	mW / °C
Isolation voltage (Note 3)		$BV_S$	5000	$V_{rms}$

(Note 2): 100µs pulse, 100Hz frequency

(Note 3): AC, 1 min., R.H.≤ 60%. Apply voltage to LED pin and detector pin together.

**Recommended Operating Conditions**

Characteristic	Symbol	Min	Typ.	Max	Unit
Supply voltage	$V_{CC}$	—	5	24	V
Forward current	$I_F$	—	16	25	mA
Collector current	$I_C$	—	1	10	mA
Operating temperature	$T_{opr}$	-25	—	85	°C

## Individual Electrical Characteristics (Ta = 25°C)

Characteristic		Symbol	Test Condition	Min	Typ.	Max	Unit
LED	Forward voltage	$V_F$	$I_F = 10 \text{ mA}$	1.0	1.2	1.3	V
	Reverse current	$I_R$	$V_R = 5 \text{ V}$	—	—	10	$\mu\text{A}$
	Capacitance	$C_T$	$V = 0, f = 1 \text{ MHz}$	—	30	—	pF
Detector	Collector-emitter breakdown voltage	$V_{(BR) CEO}$	$I_C = 0.5 \text{ mA}$	80	—	—	V
	Emitter-collector breakdown voltage	$V_{(BR) ECO}$	$I_E = 0.1 \text{ mA}$	7	—	—	V
	Collector dark current	$I_D(I_{CEO})$	$V_{CE} = 24 \text{ V}$ (ambient light below 1000 lx)	—	0.01 (0.1)	0.1 (10)	$\mu\text{A}$
			$V_{CE} = 24 \text{ V}$ (ambient light Ta = 85°C below 1000 lx)	—	0.6 (1)	50 (50)	$\mu\text{A}$
Capacitance (collector to emitter)	$C_{CE}$	$V = 0, f = 1 \text{ MHz}$	—	10	—	pF	

## Coupled Electrical Characteristics (Ta = 25°C)

Characteristic	Symbol	Test Condition	Min	Typ.	Max	Unit
Current transfer ratio	$I_C / I_F$	$I_F = 5 \text{ mA}, V_{CE} = 5 \text{ V}$ Rank GB	50	—	600	%
			100	—	600	
Saturated CTR	$I_C / I_F(\text{sat})$	$I_F = 1 \text{ mA}, V_{CE} = 0.4 \text{ V}$ Rank GB	—	60	—	%
			30	—	—	
Collector-emitter saturation voltage	$V_{CE}(\text{sat})$	$I_C = 2.4 \text{ mA}, I_F = 8 \text{ mA}$ $I_C = 0.2 \text{ mA}, I_F = 1 \text{ mA}$ Rank GB	—	—	0.4	V
			—	0.2	—	
			—	—	0.4	

## Isolation Characteristics (Ta = 25°C)

Characteristic	Symbol	Test Condition	Min	Typ.	Max	Unit
Capacitance (input to output)	$C_S$	$V_S = 0, f = 1 \text{ MHz}$	—	0.8	—	pF
Isolation resistance	$R_S$	$V_S = 500 \text{ V}$	$1 \times 10^{12}$	$10^{14}$	—	$\Omega$
Isolation voltage	$BV_S$	AC, 1 minute	5000	—	—	$V_{\text{rms}}$
		AC, 1 second, in oil	—	10000	—	
		DC, 1 minute, in oil	—	10000	—	Vdc

**Switching Characteristics (Ta = 25°C)**

Characteristics	Symbol	Test Condition	Min	Typ.	Max	Unit
Rise time	$t_r$	$V_{CC} = 10\text{ V}, I_C = 2\text{ mA}$ $R_L = 100\Omega$	—	2	—	$\mu\text{s}$
Fall time	$t_f$		—	3	—	
Turn-on time	$t_{on}$		—	3	—	
Turn-off time	$t_{off}$		—	3	—	
Turn-on time	$t_{ON}$	$R_L = 1.9\text{ k}\Omega$ $V_{CC} = 5\text{ V}, I_F = 16\text{ mA}$ (Fig.1)	—	2	—	$\mu\text{s}$
Storage time	$t_s$		—	25	—	
Turn-off time	$t_{OFF}$		—	50	—	

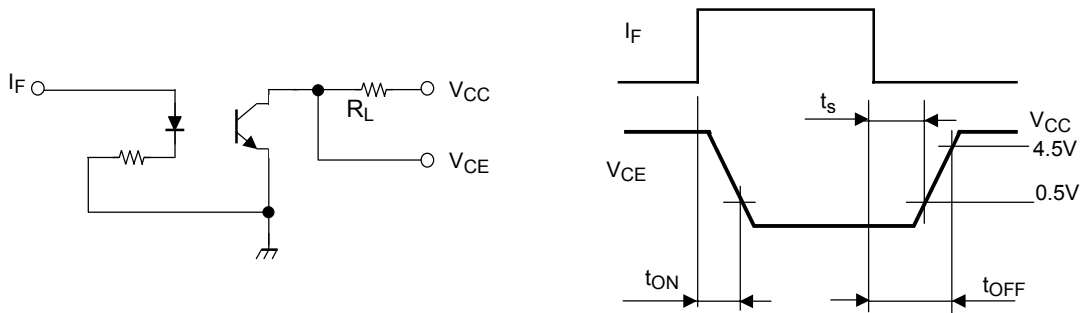
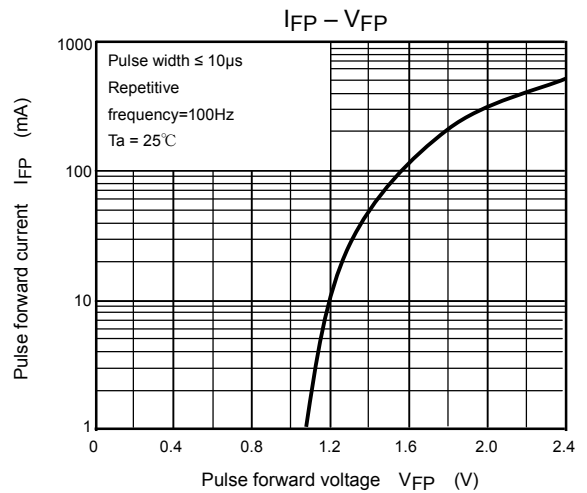
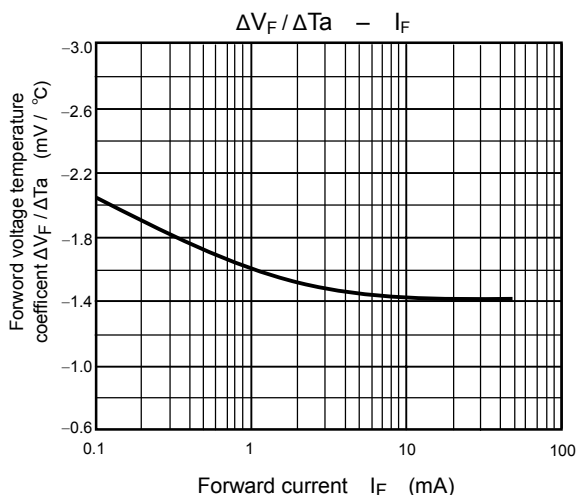
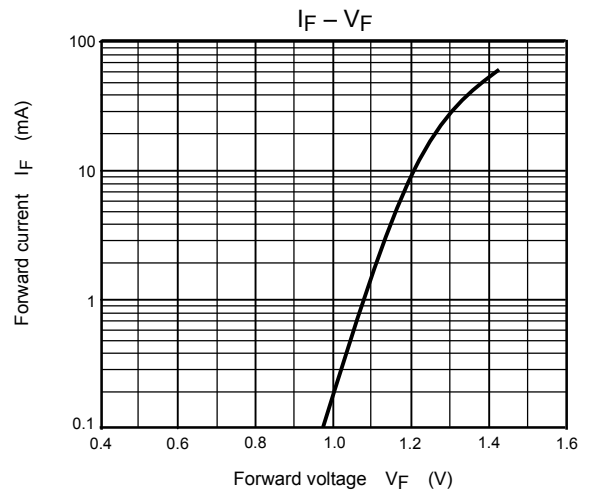
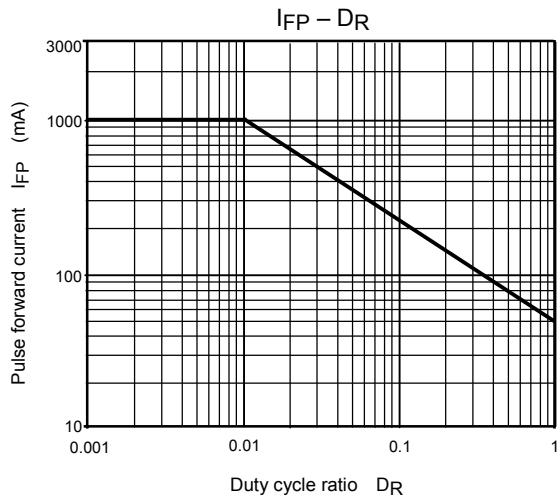
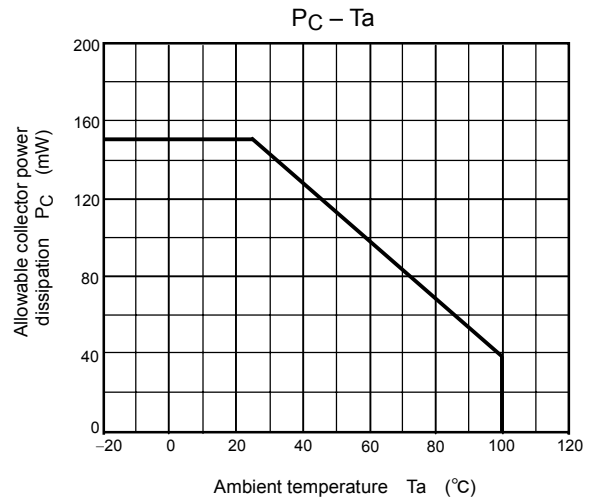
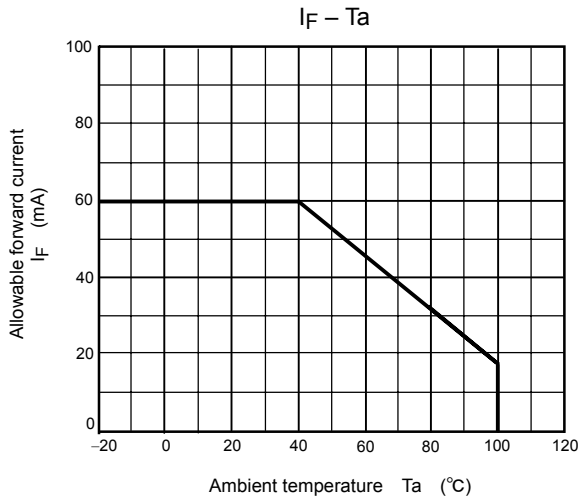
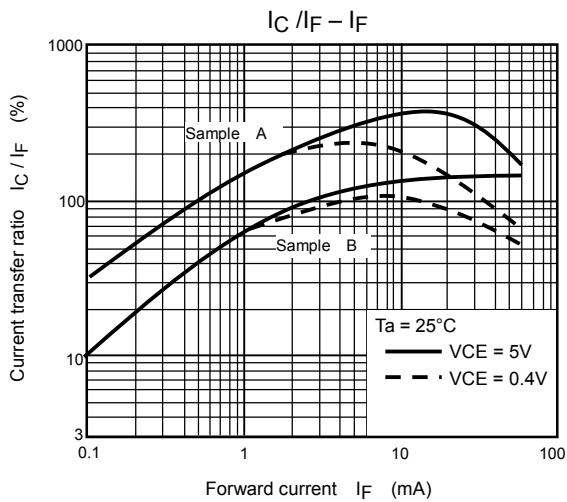
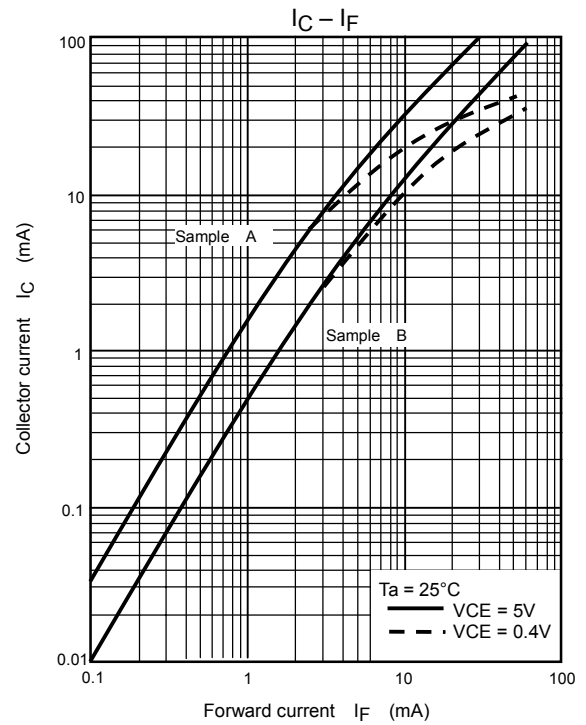
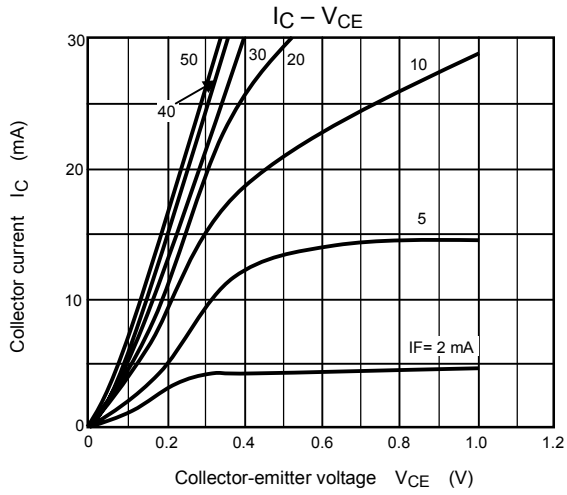
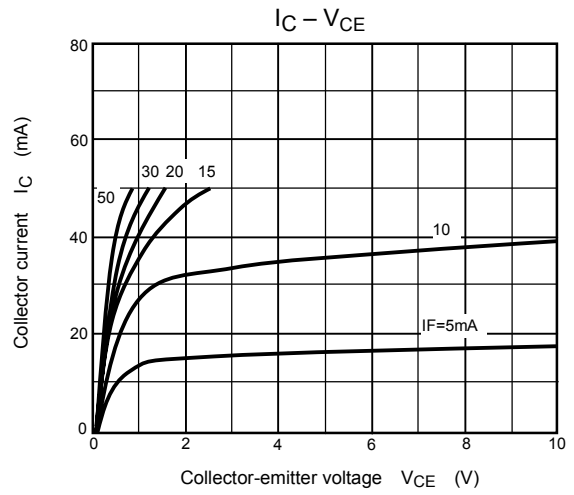
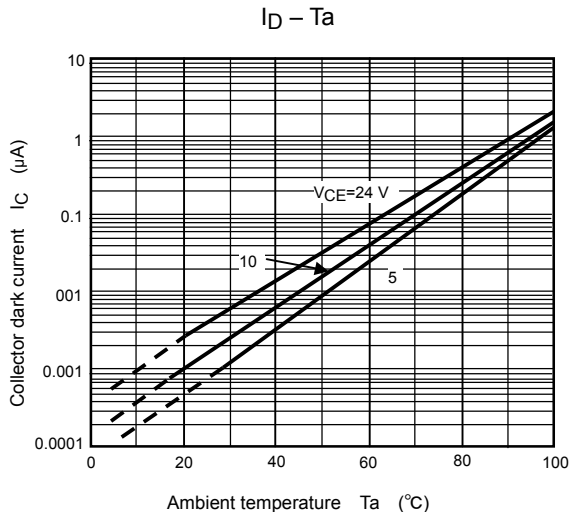
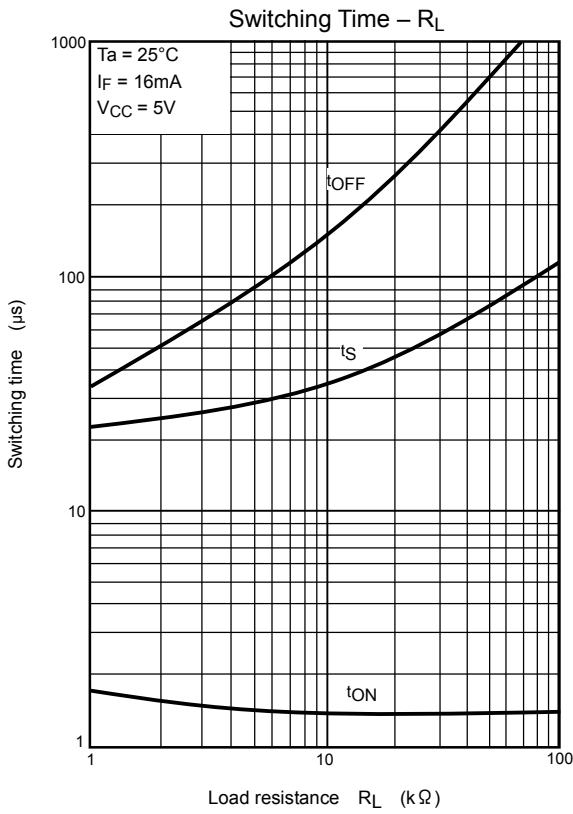
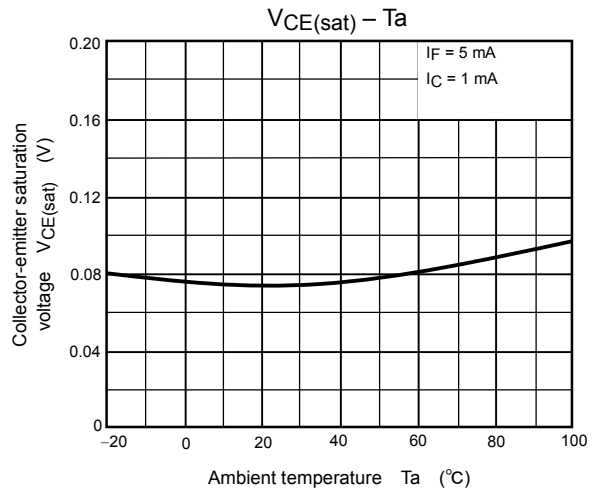
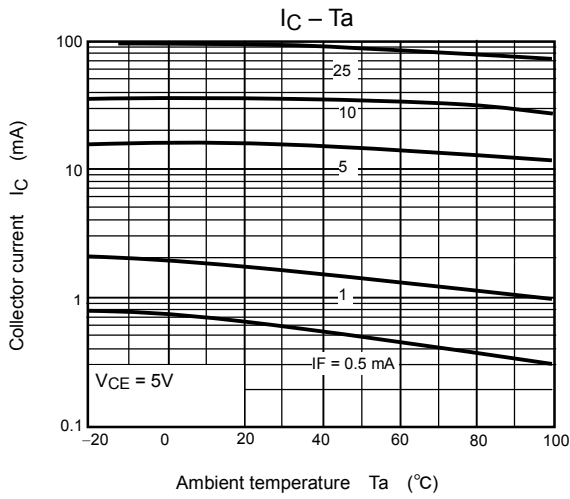

Fig.1 Switching time test circuit









**RESTRICTIONS ON PRODUCT USE**

000707EBC

- TOSHIBA is continually working to improve the quality and reliability of its products. Nevertheless, semiconductor devices in general can malfunction or fail due to their inherent electrical sensitivity and vulnerability to physical stress. It is the responsibility of the buyer, when utilizing TOSHIBA products, to comply with the standards of safety in making a safe design for the entire system, and to avoid situations in which a malfunction or failure of such TOSHIBA products could cause loss of human life, bodily injury or damage to property.  
In developing your designs, please ensure that TOSHIBA products are used within specified operating ranges as set forth in the most recent TOSHIBA products specifications. Also, please keep in mind the precautions and conditions set forth in the "Handling Guide for Semiconductor Devices," or "TOSHIBA Semiconductor Reliability Handbook" etc..
- The TOSHIBA products listed in this document are intended for usage in general electronics applications (computer, personal equipment, office equipment, measuring equipment, industrial robotics, domestic appliances, etc.). These TOSHIBA products are neither intended nor warranted for usage in equipment that requires extraordinarily high quality and/or reliability or a malfunction or failure of which may cause loss of human life or bodily injury ("Unintended Usage"). Unintended Usage include atomic energy control instruments, airplane or spaceship instruments, transportation instruments, traffic signal instruments, combustion control instruments, medical instruments, all types of safety devices, etc.. Unintended Usage of TOSHIBA products listed in this document shall be made at the customer's own risk.
- Gallium arsenide (GaAs) is a substance used in the products described in this document. GaAs dust and fumes are toxic. Do not break, cut or pulverize the product, or use chemicals to dissolve them. When disposing of the products, follow the appropriate regulations. Do not dispose of the products with other industrial waste or with domestic garbage.
- The products described in this document are subject to the foreign exchange and foreign trade laws.
- The information contained herein is presented only as a guide for the applications of our products. No responsibility is assumed by TOSHIBA CORPORATION for any infringements of intellectual property or other rights of the third parties which may result from its use. No license is granted by implication or otherwise under any intellectual property or other rights of TOSHIBA CORPORATION or others.
- The information contained herein is subject to change without notice.